

CUSTOM

# Cellular Shades

TECHNICAL GUIDE

# LEVOLOR<sup>®</sup>

# LEVOLOR® Has the Right Solutions to Make Your Home More Comfortable

Use the LEVOLOR regional climate guide to find the ideal cellular solution to overcome regional climate challenges.

Product recommendations are listed by collection, light control, and energy options based on geographic region and climate challenge.

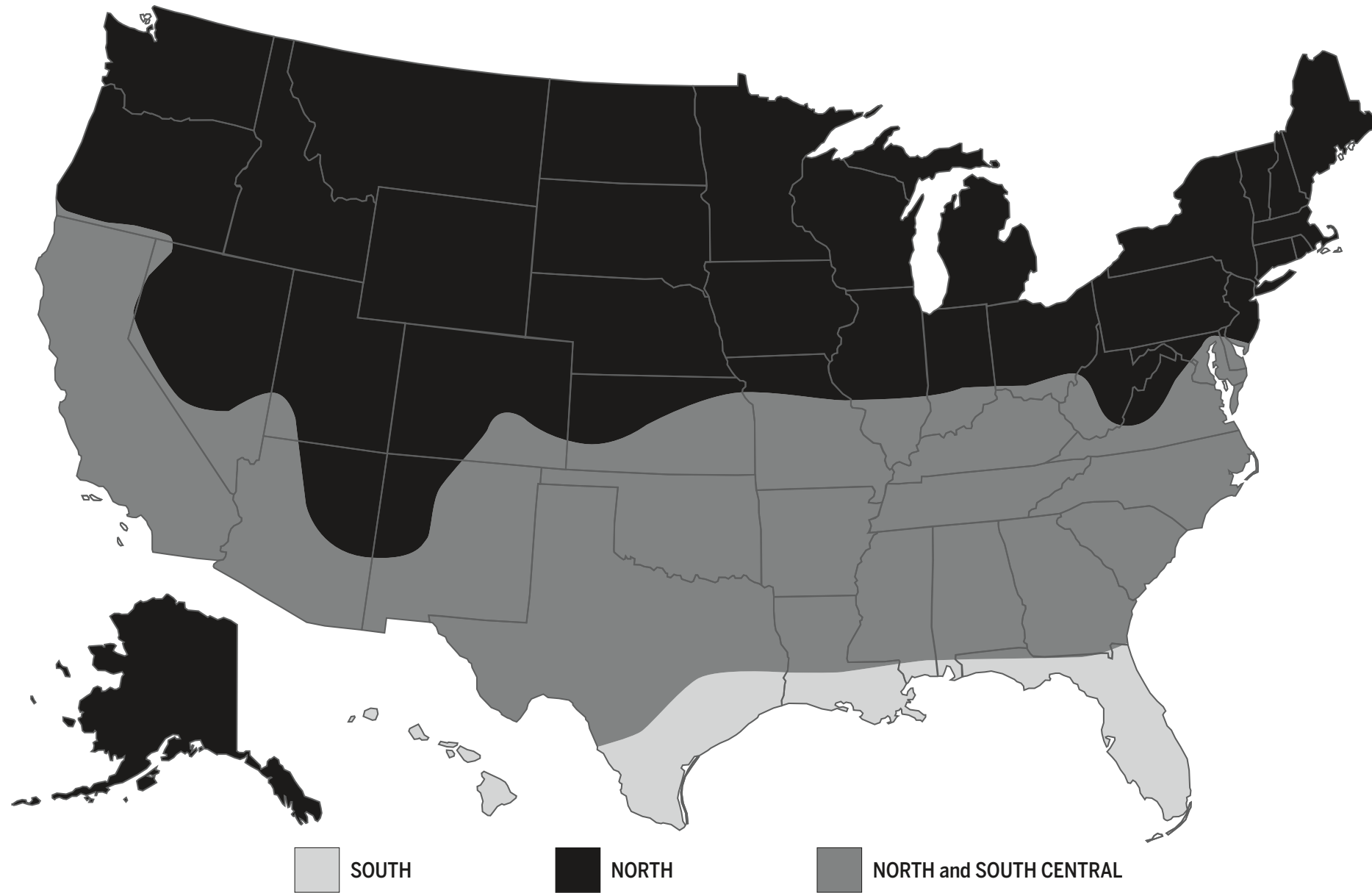

Region	Climate Challenge Description	Product Recommendations	
		Premium Woven Fabrics	Value Fabrics
North	Cool, but sunny areas where it's important to allow the sun to heat the room to keep heating costs down.	Sheer Essence, Energy Shield, Single Cell	Tricot, Light Filtering, Double Cell
		Linen, Energy Shield, Single Cell	Estria, Light Filtering, Double Cell
North and South Central	Transitional areas with cold and warm air where both heating and cooling costs are a concern.	Designer Textures, Light Filtering, Single Cell	Estria, Light Filtering, Double Cell
		Heathered, Light Filtering, Single Cell	Tricot, Light Filtering, Double Cell
South	Warm, sunny areas where it's important to block the sun from heating the room.	Tree Bark, Room Darkening, Single Cell	Designer Colors, Room Darkening, Double Cell
		Seclusions, Room Darkening, Single Cell	N/A

For additional product information visit [LEVOLOR.com/customcellular](https://www.levolor.com/customcellular)

# Understanding How LEVOLOR® Custom Cellular Shades Help Insulate Your Home

Windows provide a beautiful view to the world outside your home. They also account for a significant amount of your home's heating and cooling costs. A cellular shade complements the beauty of your home decor, while providing important benefits like insulation and eliminating unwanted air flow. LEVOLOR Custom Cellular shades aren't just stylish – they help keep your home more comfortable. Here's how:

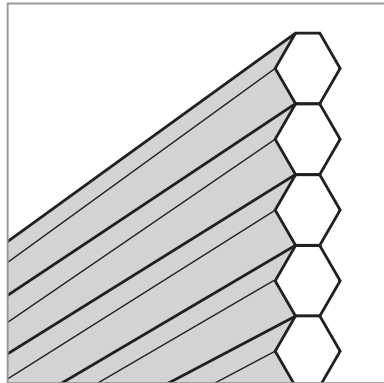

## Honeycomb Fabric Shape

- The fabric's honeycomb shape traps hot and cold air in cellular pockets reducing air flow into your home.

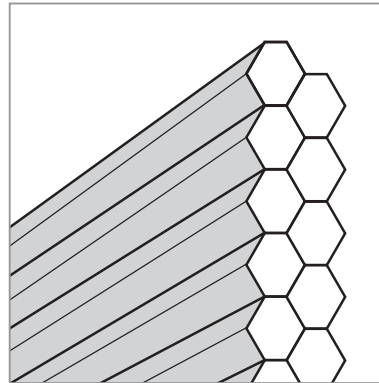

## Double Cell Fabric Construction

- The Double Cell option features two layers of cells between your room and the window, providing an additional insulation barrier.

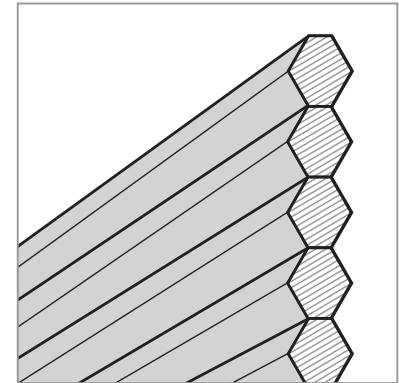

## Energy Shield™ Liner

- Our exclusive Energy Shield™ liner is a thin, clear layer inside the cells that can provide additional year-round insulation.

## Factors to consider when selecting your LEVOLOR Custom Cellular Shades:

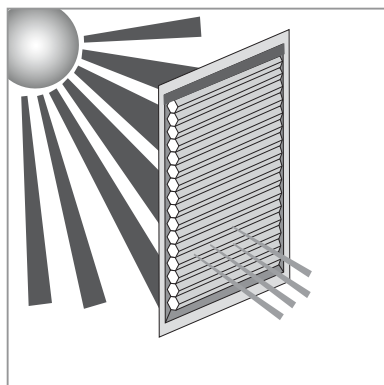

## Solar Heat Gain Coefficient (SHGC)

- How much solar energy passes into your home. A higher SHGC allows the sun to heat the room. A lower SHGC blocks the sun.

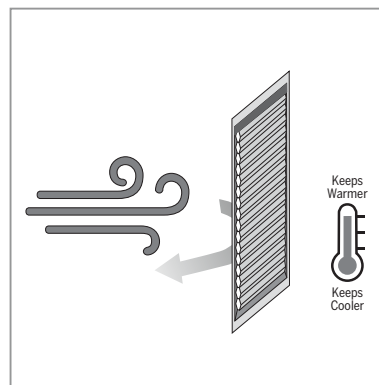

## R-Value

- Your shade's ability to block cold air in the winter and warm air in the summer. A higher R-value indicates better insulation.

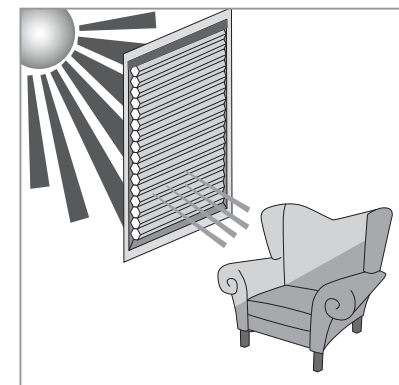

## Ultraviolet Protection Factor (UPF)

- How well your shade protects from solar UV rays, which can fade furnishings, floors and artwork. UPF ratings range from 15 (good) to 50 (excellent).

LEVOLOR is a member of the Attachments Energy Rating Council (AERC), whose goal is to help consumers make informed decisions about purchasing window attachments to maximize energy savings. Search "AERC" in your Internet browser for more information.

# How To Measure Quickly and Accurately

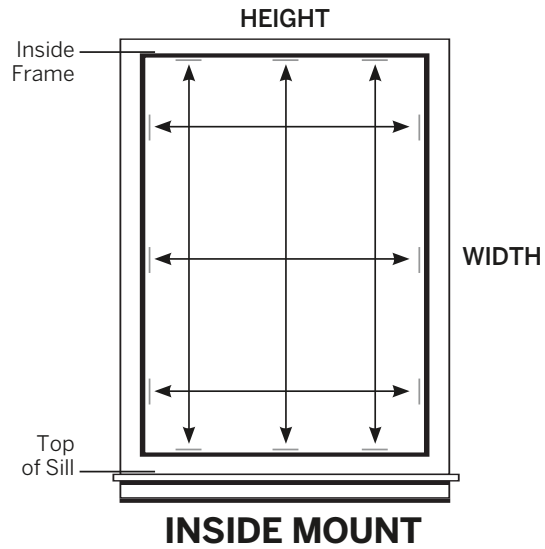

## INSIDE MOUNT (IM) INSTALLATION — For a beautiful framed look

### 1 MEASURE WIDTH

Measure to the nearest 1/8 in. between inside surfaces of window frame; at the top, middle, and bottom.

Record the narrowest width of the three.

### 2 MEASURE HEIGHT

Measure to the nearest 1/8 in. from inside surface at top of window to top of sill; at the left, middle, and right.

Record the tallest height of the three.

### 3 MEASURE DEPTH

Measure exact depth of window casing making note of any obstacles i.e. handles, tracks or cranks that could interfere with the blind or shade function.

Use the shortest depth.

## HELPFUL HINTS

Always use a metal tape measure as cloth may stretch

Measure your window - not your existing blind or shade

Measure each window separately even if they appear to be identical

Check depth to ensure shade will clear any obstacles and can accommodate headrail if flush mount is desired

If you prefer shade not to touch sill, deduct 1/4"

If there is no sill, measure height to point where shade is to reach

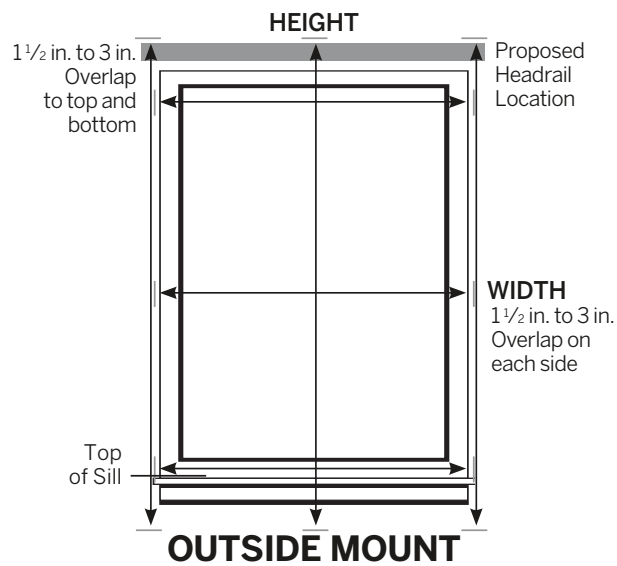

## OUTSIDE MOUNT (OM) INSTALLATION — For increased light control and privacy

### 1 MEASURE WIDTH

Measure to the nearest 1/8 in. between outermost points where shade is to be placed. Measurement should overlap each side of window frame by at least 1 1/2 in.

### 2 MEASURE HEIGHT

Measure to the nearest 1/8 in. from where top of shade will be located to top of sill, or measure to point of shade reach if no sill.

**NOTE:** Take all measurements to the nearest 1/8 in. **DO NOT** take any deductions. The factory will make the necessary adjustments to help ensure your window covering operates smoothly.

Visit [www.LEVOLOR.com/how-to-measure](http://www.LEVOLOR.com/how-to-measure) for more measuring information

## Window and Measuring Terminology

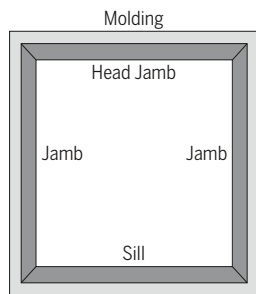

### WINDOW COMPONENTS TERMINOLOGY

- Collectively, the sill and jambs are called the "window casement" or "frame".

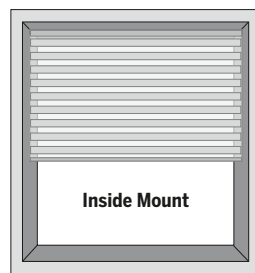

### INSIDE MOUNT

- Shade fits within window opening.
- Great for windows with beautiful trim.

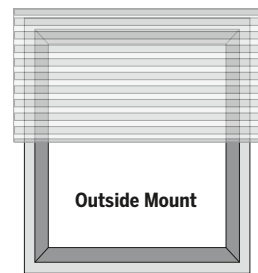

### OUTSIDE MOUNT

- Shade mounts outside window opening.
- Increased light control and privacy.

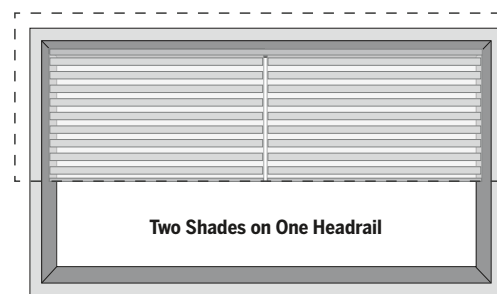

### TWO SHADES ON ONE HEADRAIL

- Provides the clean appearance of a single shade with the ability to operate each shade independently.
- Can be mounted inside or outside.

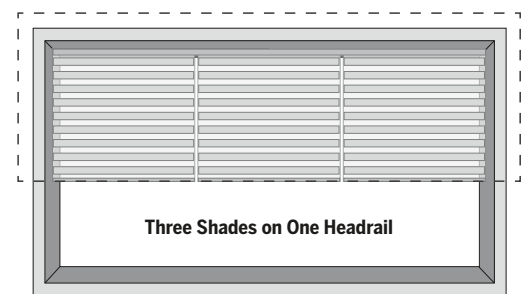

### THREE SHADES ON ONE HEADRAIL

- Provides the clean appearance of a single shade with the ability to operate each shade independently.
- Can be mounted inside or outside.

### SIDE MOUNT—NOT ILLUSTRATED

- Used primarily when conventional mounting will not work—for example, in an arched window opening.

For additional product information visit [LEVOLOR.com/customcellular](http://LEVOLOR.com/customcellular)

# How to Measure Multiple Shades on One Headrail (2-on-1 or 3-on-1 Headrail)

## INSIDE MOUNT (IM) INSTALLATION — For a beautiful framed look

### 1 MEASURE WIDTH

**Total Shade Width** — Measure to the nearest  $\frac{1}{8}$  in. between inside surfaces of window frame; at the top, middle, and bottom.

**Record the narrowest width of the three.**

**Left Shade Width** — Measure the width that you want the left shade to cover.

**Order this shade first when placing your order.**

**Right Shade Width** (for 3-on-1 only) — Measure the width that you want the right shade to cover.

### 2 MEASURE HEIGHT

**Overall Shade Height** — Measure to the nearest  $\frac{1}{8}$  in. from inside surface at top of window to top of sill; at the left, middle and right.

**Record the tallest height of the three.**

### 3 MEASURE DEPTH

Measure exact depth of window casing making note of any obstacles i.e. handles, tracks or cranks that could interfere with the blind or shade function.

**Use the shortest depth.**

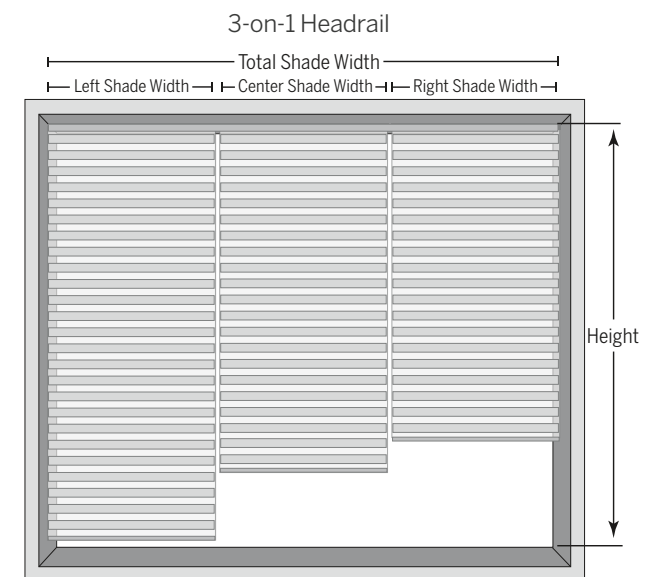
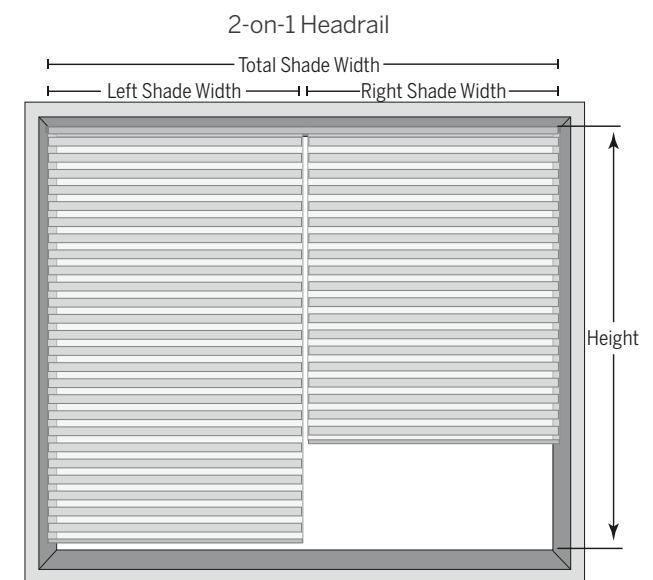

## OUTSIDE MOUNT (OM) INSTALLATION — For increased light control and privacy

### 1 MEASURE WIDTH

**Overall Shade Width** — Measure to the nearest  $\frac{1}{8}$  in. between outermost points where shade is to be placed.

**Add an additional 3 in. to 6 in. to total width for maximum privacy.**

**Left Shade Width** — Measure the width that you want the left shade to cover.

**Order this shade first when placing your order.**

**Right Shade Width** (for 3-on-1 only) — Measure the width that you want the right shade to cover.

### 2 MEASURE HEIGHT

**Overall Shade Height** — Measure to the nearest  $\frac{1}{8}$  in. from where top of shade will be located to top of sill, or measure to point of shade reach if no sill.

#### 2-ON-1 & 3-ON-1 HELPFUL NOTES:

- Order the left shade first when placing order
- Each shade operates separately
- There will be a gap between the fabric on the left and right shades to operate independently
- Fabrics cannot be seamed or overlapped
- Always use a metal tape measure as cloth may stretch
- Take all measurements to the nearest  $\frac{1}{8}$  inch. DO NOT take any deductions
- The factory will make the necessary adjustments to help ensure your shade operates smoothly
- Panel sizes follow single shade size limits, see critical dimensions page for details

#### 2-ON-1 HELPFUL NOTES:

- Available in cordless, corded, and continuous cord loop operating systems
- Top-Down/Bottom-Up and Day/Night options available
- For standard Bottom-Up shades, controls will be located on the left side of the left shade and the right side of the right shade

#### 3-ON-1 HELPFUL NOTES:

- Available in cordless bottom-up operating system only

See critical dimensions section on page 7 for additional information.

# Product Specifications

Use technical information listed below to assist in product selection.

Operating System & Shade Function Combinations					
Shade Type	Shade Function	Operating System			
		Corded	Continuous Cord Loop	Cordless	Motorized
Single Shade	Bottom-Up	✓	✓	✓	✓
	Top-Down/Bottom-Up	✓	N/A	✓	✓
	Day/Night	✓	N/A	✓	✓
2-on-1	Bottom-Up	✓	✓	✓	N/A
	Top-Down/Bottom-Up	N/A	N/A	✓	N/A
	Day/Night	N/A	N/A	✓	N/A
3-on-1	Bottom-up	N/A	N/A	✓	N/A

Headrail and Bottom Rail Dimensions (inches)				
NOTE: Reference Minimum Depth Requirements chart for required depths needed for proper installation.				
Operating System	Headrail Dimensions		Bottom Rail Dimensions	
	Depth	Height	Depth	Height
Corded 3/16" Single Cell	1 7/8	3/16	1 1/2	7/16
Corded Double Cell	2 1/8	3/16	1 3/4	5/8
Cordless (single cell/ double cell)	1 7/8	1 3/8	1 3/4	5/8
Continuous Cord Loop (single cell/double cell)	1 7/8	1 3/8	1 3/4	5/8
Motorized	2 1/16	1 3/8	1 3/4	5/8

Installation Brackets					
Your order will include the correct number of installation brackets for your shade width, as shown in the table below.					
Shade Width (inches)	Number of Brackets				
	Corded	Cordless, and Continuous Cord Loop	Corded 2-on-1	Cord Loop 2-on-1	Cordless 2-on-1 3-on-1
Up to 38	2	2	2	2	2
38 to 68	3	3	3	3	3
68 to 82	4	3	4	3	3
82 to 106	5	4	5	4	4
106 to 130	6	4	6	4	4
130 and above	N/A	N/A	7	6	N/A

Installation Brackets	
Shade Width (inches)	Number of Brackets
Motorized	
Up to 36	2
36 to 72	3
72 to 108	4
108 to 144	5

Standard Factory Deductions (inches)			
DO NOT make any deductions to your measurements			
	Inside Mount*	Outside Mount	Side Mount
Standard Corded	3/8	0	5/8
Cordless	3/8	0	5/8
Continuous Cord Loop	3/8	0	5/8
Motorized	3/8	0	5/8

Note: End caps will add an additional 3/16 inch to the total headrail dimensions.  
\*There is a 3/16 inch light gap on the left and right side of an inside mount shade.

Continuous Cord Loop Cord Lengths		
Minimum Shade Length (inches)	Maximum Shade Length (inches)	Length (feet)
18	48	2
48 1/8	60	3
60 1/8	72	4
72 1/8	96	6
96 1/8	119 7/8	8
120	above 120	10

The control lengths for cord loops may be changed from default lengths. Please refer to retail ordering system for details.

Corded Shade Cord Lengths
Cord length is approximately 1/2 the length of the shade. Custom cord lengths can be requested at time of order. Custom cord lengths available in 1" increments from 10" to 144"

Lift Control Operation & Options					
Shade Type	Shade Function	Operating System			
		Corded	Continuous Cord Loop	Cordless	Motorized
Single Shade	Bottom-Up	Left or right control, left is standard	Left or right control, left is standard	Handle operates shade	Right control only
	Top-Down/Bottom-Up	Left control operates bottom rail Right control operates middle rail	N/A	Handle operates shade	Right control only
	Day/Night	Left control operates bottom rail Right control operates middle rail	N/A	Handle operates shade	Right control only
2-on-1	Bottom-Up	Left control operates left shade Right control operates right shade	Left control operates left shade Right control operates right shade	Handle operates shade	N/A
	Top-Down/Bottom-Up	N/A	N/A	Handle operates shade	N/A
	Day/Night	N/A	N/A	Handle operates shade	N/A
3-on-1	Bottom-up	N/A	N/A	Handle operates shade	N/A

For additional product information visit [LEVOLOR.com/customcellular](http://LEVOLOR.com/customcellular)

# Critical Dimensions

To ensure your window covering selection is available and will fit properly, refer to critical dimension information below.

Single Shade Critical Dimensions (inches)				
NOTE: Some fabric limitations may apply.				
Cordless Bottom-Up	Min Width	Max Width	Min Length	Max Length
Side Mount	10	48	6	72
Inside Mount	10	120 <sup>‡</sup>	6	96* <sup>†</sup>
Outside Mount	10	120 <sup>‡</sup>	6	96* <sup>†</sup>
<sup>‡</sup> Fabric Limitations: Maximum width is 84" for all Seclusions, Tree Bark & Heathered. <sup>*</sup> Fabric Limitations: Maximum length is 84" for all Seclusions, Tree Bark & Heathered. <sup>†</sup> For cordless shade widths smaller than 15" the maximum length is 84".				
Cordless TDBU and Day/Night	Min Width	Max Width	Min Length	Max Length
Side Mount	16	48	6	72
Inside Mount	16 <sup>§</sup>	96 <sup>§</sup>	6	84 <sup>§</sup>
Outside Mount	16 <sup>§</sup>	96 <sup>§</sup>	6	84 <sup>§</sup>
<sup>§</sup> Fabric Limitations: See chart below for all Seclusions, Tree Bark & Heathered limitations.				
Corded Bottom-Up	Min Width	Max Width	Min Length	Max Length
Side Mount	6	48	6	72
Inside Mount	6	120	6	144
Outside Mount	6	120	6	144
Corded TDBU and Day/Night	Min Width	Max Width	Min Length	Max Length
Side Mount	12	48	6	72
Inside Mount	12	72	6	96
Outside Mount	12	72	6	96
Continuous Cord Loop Bottom-Up	Min Width	Max Width	Min Length	Max Length
Side Mount	18	48	18	72
Inside Mount	18	120	18	144 <sup>¶</sup>
Outside Mount	18	120	18	144 <sup>¶</sup>
<sup>¶</sup> For continuous cord loop shade widths smaller than 32" the maximum length is 96".				

Single Shade Critical Dimensions (inches) — Fabric Limitations				
NOTE: For Single Shades with Cordless TDBU and Cordless Day/Night Operating Systems ONLY				
Seclusions Collections (LF, RD & ES)	Min Width	Max Width	Min Length	Max Length
TDBU and Day/Night	19	84	6	84* <sup>†</sup>
<sup>*</sup> For shade widths smaller than 21" the maximum length is 72" for LF & ES fabric. <sup>†</sup> For shade widths smaller than 21" the maximum length is 41" for RD fabric.				
Tree Bark Collection (LF, RD & ES)	Min Width	Max Width	Min Length	Max Length
TDBU and Day/Night	19	84	6	84 <sup>‡§</sup>
<sup>‡</sup> For shade widths smaller than 21" the maximum length is 53" for LF & ES fabric. <sup>§</sup> For shade widths smaller than 21" the maximum length is 40" for RD fabric.				
Heathered Collection (LF, RD & ES)	Min Width	Max Width	Min Length	Max Length
TDBU and Day/Night	19	84	6	84 <sup>¶</sup>
<sup>¶</sup> For shade widths smaller than 21" the maximum length is 72" for LF & ES fabric. <sup>¶</sup> For shade widths smaller than 21" the maximum length is 60" for RD fabric.				

TDBU= Top-Down / Bottom-Up

Single Shade Critical Dimensions (inches)				
NOTE: Some fabric limitations may apply.				
Motorized Bottom-Up	Min Width	Max Width	Min Length	Max Length
Inside Mount	26	120	12	144
Outside Mount	26	120	12	144
Side Mount	26	36	12	72
Motorized TDBU and Day/Night	Min Width	Max Width	Min Length	Max Length
Inside Mount	30 ½	120	12	144
Outside Mount	30 ½	120	12	144
Side Mount	30 ½	36	12	72

2-on-1 Critical Dimensions (inches)				
NOTE: Some fabric limitations may apply.				
Cordless Bottom-Up	Min Width	Max Width	Min Length	Max Length
Side Mount	20	48	6	72
Inside Mount	20	120	6	96* <sup>†</sup>
Outside Mount	20	120	6	96* <sup>†</sup>
<sup>*</sup> Fabric Limitations: for Seclusions, Tree Bark & Heathered maximum length is 84". <sup>†</sup> For shade widths smaller than 29" the maximum length is 84".				
Cordless TDBU and Day/Night	Min Width	Max Width	Min Length	Max Length
Side Mount	32	48	6	72
Inside Mount	32	96	6	84
Outside Mount	32	96	6	84
Corded Bottom-Up	Min Width	Max Width	Min Length	Max Length
Side Mount	24	48	6	72
Inside Mount	12	144	6	144
Outside Mount	12	144	6	144
Continuous Cord Loop Bottom-Up	Min Width	Max Width	Min Length	Max Length
Side Mount	36	48	18	72
Inside Mount	36	144	18	144 <sup>‡</sup>
Outside Mount	36 ¼	144	18	144 <sup>§</sup>
<sup>‡</sup> For shade widths smaller than 55" and greater than 120" the maximum length is 96". <sup>§</sup> For shade widths greater than 120" the maximum length is 96".				

3-on-1 Critical Dimensions (inches)				
NOTE: Some fabric limitations may apply.				
Cordless Bottom-Up	Min Width	Max Width	Min Length	Max Length
Inside Mount	30	120	6	96*
Outside Mount	30	120	6	96*
*Standard shade restrictions apply to each panel.				

Minimum Depth Requirements for Proper Shade Installation (inches)		
Operating System	Minimum Mounting Depth	Minimum Depth for Fully Recessed / Flush Mount Headrail
Corded	5/8	2 ½
Continuous Cord Loop	½	2 ⅜
Cordless	½	2 ⅝
Motorized	1 ¼	2 ¼

# Motorized Limits

Due to the unique weight and structure of each fabric type there are different size limitations for Bottom-Up, Top-Down/Bottom-Up (TDBU) and Day/Night motorized shades.

## Key

	No motorized shades are available due to large shade size.		Only Bottom-Up motorized shades are available.
			Bottom-Up, Top-Down/Bottom-Up and Day/Night motorized shades are available.

Classic Collection – Single Cell (inches)																	
Width	20	24	28	36	42	48	54	60	66	72	84	96	108	120	132	144	
Height																	
36	Not offered due to small shade size																
42																	
48																	
54																	
60																	
66																	
72																	
78																	
84																	
90																	
96																	
108																	
120																	
132																	
144																	

Designer Colors, Estria & Tricot Collections – Single Cell (inches)																	
Width	20	24	28	36	42	48	54	60	66	72	84	96	108	120	132	144	
Height																	
36	Not offered due to small shade size																
42																	
48																	
54																	
60																	
66																	
72																	
78																	
84																	
90																	
96																	
108																	
120																	
132																	
144																	

# Motorized Limits

Due to the unique weight and structure of each fabric type there are different size limitations for Bottom-Up, Top-Down/Bottom-Up (TDBU) and Day/Night motorized shades.

## Key

	No motorized shades are available due to large shade size.		Only Bottom-Up motorized shades are available.		Bottom-Up, Top-Down/Bottom-Up and Day/Night motorized shades are available.
--	--	--	--	--	---

Designer Colors, Estria & Tricot Collections – Double Cell (inches)																	
Width	20	24	28	36	42	48	54	60	66	72	84	96	108	120	132	144	
Height																	
36	Not offered due to small shade size																
42																	
48																	
54																	
60																	
66																	
72																	
78																	
84																	
90																	
96																	
108																	
120																	
132																	
144																	

Designer Textures Collection – Single Cell (inches)																	
Width	20	24	28	36	42	48	54	60	66	72	84	96	108	120	132	144	
Height																	
36	Not offered due to small shade size																
42																	
48																	
54																	
60																	
66																	
72																	
78																	
84																	
90																	
96																	
108																	
120																	
132																	
144																	

# Motorized Limits

Due to the unique weight and structure of each fabric type there are different size limitations for Bottom-Up, Top-Down/Bottom-Up (TDBU) and Day/Night motorized shades.

## Key

	No motorized shades are available due to large shade size.		Only Bottom-Up motorized shades are available.		Bottom-Up, Top-Down/Bottom-Up and Day/Night motorized shades are available.
--	--	--	--	--	---

Linen Collection – Single Cell (inches)																
Width	20	24	28	36	42	48	54	60	66	72	84	96	108	120	132	144
Height																
36	Not offered due to small shade size															
42																
48																
54																
60																
66																
72																
78																
84																
90																
96																
108																
120																
132																
144																

Heathered, Seclusions & Tree Bark – Single Cell (inches)																
Width	20	24	28	36	42	48	54	60	66	72	84	96	108	120	132	144
Height																
36	Not offered due to small shade size															
42																
48																
54																
60																
66																
72																
78																
84																
90																
96																
108																
120																
132																
144																

# Motorized Limits

Due to the unique weight and structure of each fabric type there are different size limitations for Bottom-Up, Top-Down/Bottom-Up (TDBU) and Day/Night motorized shades.

## Key

	No motorized shades are available due to large shade size.		Only Bottom-Up motorized shades are available.		Bottom-Up, Top-Down/Bottom-Up and Day/Night motorized shades are available.
--	--	--	--	--	---

Sheer Essence Collection – Single Cell (inches)																
Width	20	24	28	36	42	48	54	60	66	72	84	96	108	120	132	144
Height																
36																
42																
48																
54																
60																
66																
72																
78	Not offered due to small shade size															
84																
90																
96																
108																
120																
132																
144																

# Fabric Index—Premium Woven Fabrics

Premium Woven Fabrics						
Collection	Cell Size	Color	Light Filtering	Room Darkening	Energy Shield™	Hardware Color
Heathered	Single Cell	Cream	19BMT015	19GMT015	19FMT015	80012
		Graphite	19BMT016	19GMT016	19FMT016	50002
		Rosemary	19BGE007	19GGE007	19FGE007	70121
		Sand	19BBR018	19GBR018	19FBR018	80012
		Sea Glass	19BBL008	19GBL008	19FBL008	80166
		Slate	19BMT019	19GMT019	19FMT019	50002
		Toffee	19BMT020	19GMT020	19FMT020	70152
		Whisper	19BMT021	19GMT021	19FMT021	00110
Tree Bark	Single Cell	Antique Gold	19CGT002	19HGT002	19GGT002	80006
		Cream	19C70202	19H70202	19G70202	80012
		Light Fog	19CGY008	19HGY008	19GGY008	50002
		Marine	19CBL007	19HBL007	19GBL007	70134
		Raffia	19C70331	19H70331	19G70331	70114
		Sand	19C70247	19H70247	19G70247	80204
		Snow	19C70199	19H70199	19G70199	00110
		Toffee	19C70216	19H70216	19G70216	80120
Seclusions	Single Cell	Biscuit	19AMT023	19FMT023	19HMT023	80204
		Graphite	19AMT024	19FMT024	19HMT024	50002
		Light Gray	19AGY017	19FGY017	19HGY017	80166
		Mocha	19AMT025	19FMT025	19HMT025	70152
		Navy	19AMT026	19FMT026	19HMT026	80310
		Praline	19AYW002	19FYW002	19HYW002	80120
		Rosemary	19AGE006	19FGE006	19HGE006	70121
		White	19AMT028	19FMT028	19HMT028	00110
Linen	Single Cell	Antique Gold	191GT001	197GT001	19QGT001	80006
		Candlelight	19170105	19770105	19Q70105	80006
		Cream	19170202	19770202	19Q70202	80012
		Light Gray	19170343	19770343	19Q70343	80166
		Mink	19170110	19770110	19Q70110	80204
		Pearl	191WH023	197WH023	19QWH023	00110
		Rosemary	191GE004	197GE004	19QGE004	70121
		Sand	19170247	19770247	19Q70247	80204
		Slate	19170800	19770800	19Q70800	70800
		Toffee	19170216	19770216	19Q70216	80120
Designer Textures	Single Cell	Amethyst	193PU001	198PU001	19EPU001	80031
		Aqua	19370336	19870336	19E70336	70802
		Black	19370147	19870147	19E70147	70147
		Daylight	19370104	19870104	19E70104	80012
		Espresso	19380804	19880804	19E80804	70804
		Fresh Green	19370333	19870333	19E70333	50003
		Graphite	19370345	19870345	19E70345	50002
		Light Gray	19370343	19870343	19E70343	80166
		Marine	19370337	19870337	19E70337	70134
		Mink	19370110	19870110	19E70110	80204
		Raffia	19370331	19870331	19E70331	70114
		Rosemary	193GE004	198GE004	19EGE004	70121
		Sand	19370247	19870247	19E70247	80204
		Sangria	19370801	19870801	19E70801	70145
		Slate	19370800	19870800	19E70800	70800
		Snow	19370199	19870199	19E70199	00110
		Toffee	19370216	19870216	19E70216	80120
		Whisper	19370101	19870101	19E70101	00110
Sheer Essence	Single Cell	Cream	N/A	N/A	19670202	80012
		Graphite	N/A	N/A	19670345	50002
		Snow	N/A	N/A	19670199	00110
		Toffee	N/A	N/A	19670216	80120
		Tumbleweed	N/A	N/A	19670108	80204

For additional product information visit [LEVOLOR.com/customcellular](http://LEVOLOR.com/customcellular)

# Fabric Index—Value Fabrics

Value Fabrics						
Collection	Color	Single Cell		Double Cell		Hardware Color
		Light Filtering	Room Darkening	Light Filtering	Room Darkening	
Estria	Cream	19K70202	19X7020	12K70202	12X70202	80012
	Doe	19KBR017	19XBR017	12KBR017	12XBR017	80204
	Espresso	19K80804	19X80804	12K80804	12X80804	70804
	Graphite	19K70345	19X70345	12K70345	12X70345	50002
	Nimbus Cloud	19KBT004	19XBT004	12KBT004	12XBT004	80001
	Rosemary	19KGE005	19XGE005	12KGE005	12XGE005	70121
	Snow	19K70199	19X70199	12K70199	12X70199	00110
	Summer Sky	19KBL006	19XBL006	12KBL006	12XBL006	70802
Tricot	Chipotle	19RRE003	19NRE003	12RRE003	12NRE003	00292
	Daylight	19R70104	19N70104	12R70104	12N70104	80012
	Hazelnut	19RBR019	19NBR019	12RBR019	12NBR019	70114
	Light Gray	19R70343	19N70343	12R70343	12N70343	80166
	Marine	19R70337	19N70337	12R70337	12N70337	70134
	Mink	19R70110	19N70110	12R70110	12N70110	80120
	Sand	19R70247	19N70247	12R70247	12N70247	80204
	Whisper	19R70101	19N70101	12R70101	12N70101	80012
Designer Colors	Aqua	19470336	19970336	12470336	12970336	70802
	Ash	194GY050	199GY050	124GY050	129GY050	GY051
	Black	19470147	19970147	12470147	12970147	70147
	Blush	194RE010	199RE010	124RE010	129RE010	RE011
	Brick	194BE016	199BE016	124BE016	129BE016	OR001
	Cabernet	194BL013	199BL013	124BL013	129BL013	00275
	Cashmere	194YW008	199YW008	124YW008	129YW008	70114
	Daylight	19470104	19970104	12470104	12970104	80012
	Espresso	19480804	19980804	12480804	12980804	70804
	Fossil	194GY049	199GY049	124GY049	129GY049	50002
	Graphite	19470345	19970345	12470345	12970345	50002
	Khaki	194BE015	199BE015	124BE015	129BE015	80204
	Latte	194BR037	199BR037	124BR037	129BR037	BE018
	Medallion	194YW009	199YW009	124YW009	129YW009	50001
	Mink	19470110	19970110	12470110	12970110	80204
	Moss	194GE009	199GE009	124GE009	129GE009	70121
	Navy	19470135	19970135	12470135	12970135	80310
	Ocean	19470141	19970141	12470141	12970141	70134
	Sage	19470803	19970803	12470803	12970803	70803
	Shell	194WH057	199WH057	124WH057	129WH057	80012
	Slate	19470800	19970800	12470800	12970800	70800
	Snow	19470199	19970199	12470199	12970199	00110
Whisper	19470101	19970101	12470101	12970101	00110	
Wisteria	194PU002	199PU002	124PU002	129PU002	70136	
Classic	Cream	19570202	19070202	N/A	N/A	80006
	Light Gray	19570343	19070343	N/A	N/A	80166
	Sand	19570247	19070247	N/A	N/A	80204
	Snow	19570199	19070199	N/A	N/A	00110
	Toffee	19570216	19070216	N/A	N/A	80120

# Stacking Chart

Stacking charts represent the amount of shade that is gathered at the top of the window, when the shade is fully raised. The measurements include the approximate height of the fabric, headrail, and bottom rail.

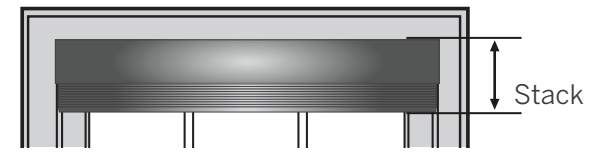

Stacking Chart — Cordless and Continuous Cord Loop and Motorized (inches)										
Fabric Collection	36	48	60	72	84	96	108	120	132	144
Classic Collection Light Filtering	2 <sup>3</sup> / <sub>4</sub>	3	3 <sup>3</sup> / <sub>8</sub>	3 <sup>5</sup> / <sub>8</sub>	4	4 <sup>1</sup> / <sub>4</sub>	4 <sup>1</sup> / <sub>2</sub>	4 <sup>7</sup> / <sub>8</sub>	5 <sup>1</sup> / <sub>8</sub>	5 <sup>1</sup> / <sub>2</sub>
Classic Collection Room Darkening	3 <sup>1</sup> / <sub>8</sub>	3 <sup>1</sup> / <sub>2</sub>	3 <sup>7</sup> / <sub>8</sub>	4 <sup>1</sup> / <sub>4</sub>	4 <sup>3</sup> / <sub>4</sub>	5	5 <sup>3</sup> / <sub>8</sub>	5 <sup>7</sup> / <sub>8</sub>	6 <sup>1</sup> / <sub>8</sub>	6 <sup>5</sup> / <sub>8</sub>
Designer Colors Collection Light Filtering	2 <sup>7</sup> / <sub>8</sub>	3 <sup>1</sup> / <sub>4</sub>	3 <sup>5</sup> / <sub>8</sub>	4	4 <sup>3</sup> / <sub>8</sub>	4 <sup>3</sup> / <sub>4</sub>	5 <sup>1</sup> / <sub>8</sub>	5 <sup>1</sup> / <sub>2</sub>	5 <sup>3</sup> / <sub>4</sub>	6 <sup>1</sup> / <sub>8</sub>
Designer Colors Collection Room Darkening	2 <sup>7</sup> / <sub>8</sub>	3 <sup>1</sup> / <sub>8</sub>	3 <sup>1</sup> / <sub>2</sub>	3 <sup>7</sup> / <sub>8</sub>	4 <sup>1</sup> / <sub>8</sub>	4 <sup>1</sup> / <sub>2</sub>	4 <sup>7</sup> / <sub>8</sub>	5 <sup>1</sup> / <sub>4</sub>	5 <sup>1</sup> / <sub>2</sub>	5 <sup>7</sup> / <sub>8</sub>
Designer Colors Collection Light Filtering Double Cell	2 <sup>5</sup> / <sub>8</sub>	2 <sup>3</sup> / <sub>4</sub>	3	3 <sup>1</sup> / <sub>4</sub>	3 <sup>1</sup> / <sub>2</sub>	3 <sup>3</sup> / <sub>4</sub>	4	4 <sup>1</sup> / <sub>4</sub>	4 <sup>1</sup> / <sub>2</sub>	4 <sup>3</sup> / <sub>4</sub>
Designer Colors Collection Room Darkening Double Cell	3 <sup>1</sup> / <sub>8</sub>	3 <sup>1</sup> / <sub>2</sub>	3 <sup>7</sup> / <sub>8</sub>	4 <sup>1</sup> / <sub>4</sub>	4 <sup>3</sup> / <sub>4</sub>	5	5 <sup>3</sup> / <sub>8</sub>	5 <sup>7</sup> / <sub>8</sub>	6 <sup>1</sup> / <sub>8</sub>	6 <sup>5</sup> / <sub>8</sub>
Designer Textures Collection Light Filtering	3	3 <sup>3</sup> / <sub>8</sub>	3 <sup>3</sup> / <sub>4</sub>	4 <sup>1</sup> / <sub>8</sub>	4 <sup>1</sup> / <sub>2</sub>	4 <sup>7</sup> / <sub>8</sub>	5 <sup>1</sup> / <sub>4</sub>	5 <sup>5</sup> / <sub>8</sub>	6	6 <sup>3</sup> / <sub>8</sub>
Designer Textures Collection Room Darkening	3	3 <sup>3</sup> / <sub>8</sub>	3 <sup>3</sup> / <sub>4</sub>	4 <sup>1</sup> / <sub>8</sub>	4 <sup>1</sup> / <sub>2</sub>	4 <sup>7</sup> / <sub>8</sub>	5 <sup>1</sup> / <sub>4</sub>	5 <sup>5</sup> / <sub>8</sub>	6 <sup>1</sup> / <sub>8</sub>	6 <sup>1</sup> / <sub>2</sub>
Designer Textures Collection With Energy Shield™	2 <sup>7</sup> / <sub>8</sub>	3 <sup>1</sup> / <sub>8</sub>	3 <sup>1</sup> / <sub>2</sub>	3 <sup>7</sup> / <sub>8</sub>	4 <sup>1</sup> / <sub>4</sub>	4 <sup>1</sup> / <sub>2</sub>	4 <sup>7</sup> / <sub>8</sub>	5 <sup>1</sup> / <sub>4</sub>	5 <sup>5</sup> / <sub>8</sub>	5 <sup>7</sup> / <sub>8</sub>
Estria Collection Light Filtering	2 <sup>3</sup> / <sub>4</sub>	3	3 <sup>3</sup> / <sub>8</sub>	3 <sup>5</sup> / <sub>8</sub>	4	4 <sup>1</sup> / <sub>4</sub>	4 <sup>1</sup> / <sub>2</sub>	4 <sup>7</sup> / <sub>8</sub>	5 <sup>1</sup> / <sub>8</sub>	5 <sup>1</sup> / <sub>2</sub>
Estria Collection Room Darkening	2 <sup>7</sup> / <sub>8</sub>	3 <sup>1</sup> / <sub>8</sub>	3 <sup>1</sup> / <sub>2</sub>	3 <sup>7</sup> / <sub>8</sub>	4 <sup>1</sup> / <sub>8</sub>	4 <sup>1</sup> / <sub>2</sub>	4 <sup>7</sup> / <sub>8</sub>	5 <sup>1</sup> / <sub>4</sub>	5 <sup>1</sup> / <sub>2</sub>	5 <sup>7</sup> / <sub>8</sub>
Estria Collection Light Filtering Double Cell	2 <sup>7</sup> / <sub>8</sub>	3 <sup>1</sup> / <sub>4</sub>	3 <sup>5</sup> / <sub>8</sub>	4	4 <sup>3</sup> / <sub>8</sub>	4 <sup>3</sup> / <sub>4</sub>	5 <sup>1</sup> / <sub>8</sub>	5 <sup>1</sup> / <sub>2</sub>	5 <sup>3</sup> / <sub>4</sub>	6 <sup>1</sup> / <sub>8</sub>
Estria Collection Room Darkening Double Cell	3 <sup>1</sup> / <sub>8</sub>	3 <sup>1</sup> / <sub>2</sub>	3 <sup>7</sup> / <sub>8</sub>	4 <sup>1</sup> / <sub>4</sub>	4 <sup>3</sup> / <sub>4</sub>	5	5 <sup>3</sup> / <sub>8</sub>	5 <sup>7</sup> / <sub>8</sub>	6 <sup>1</sup> / <sub>8</sub>	6 <sup>5</sup> / <sub>8</sub>
Heathered Collection Light Filtering	3 <sup>1</sup> / <sub>2</sub>	4	4 <sup>1</sup> / <sub>2</sub>	5	5 <sup>3</sup> / <sub>8</sub>	5 <sup>7</sup> / <sub>8</sub>	6 <sup>1</sup> / <sub>4</sub>	6 <sup>5</sup> / <sub>8</sub>	7	7 <sup>1</sup> / <sub>2</sub>
Heathered Collection Room Darkening	3 <sup>3</sup> / <sub>4</sub>	4 <sup>1</sup> / <sub>4</sub>	4 <sup>5</sup> / <sub>8</sub>	5 <sup>1</sup> / <sub>8</sub>	5 <sup>1</sup> / <sub>2</sub>	6	6 <sup>3</sup> / <sub>8</sub>	6 <sup>7</sup> / <sub>8</sub>	7 <sup>1</sup> / <sub>4</sub>	7 <sup>3</sup> / <sub>4</sub>
Heathered Collection With Energy Shield™	3 <sup>1</sup> / <sub>2</sub>	4	4 <sup>1</sup> / <sub>2</sub>	5	5 <sup>3</sup> / <sub>8</sub>	5 <sup>7</sup> / <sub>8</sub>	6 <sup>1</sup> / <sub>4</sub>	6 <sup>5</sup> / <sub>8</sub>	7	7 <sup>1</sup> / <sub>2</sub>
Linen Collection Light Filtering	3	3 <sup>3</sup> / <sub>8</sub>	3 <sup>3</sup> / <sub>4</sub>	4 <sup>1</sup> / <sub>8</sub>	4 <sup>1</sup> / <sub>2</sub>	4 <sup>7</sup> / <sub>8</sub>	5 <sup>1</sup> / <sub>4</sub>	5 <sup>5</sup> / <sub>8</sub>	6	6 <sup>3</sup> / <sub>8</sub>
Linen Collection Room Darkening	3 <sup>3</sup> / <sub>4</sub>	4 <sup>1</sup> / <sub>4</sub>	4 <sup>3</sup> / <sub>4</sub>	5 <sup>1</sup> / <sub>8</sub>	5 <sup>5</sup> / <sub>8</sub>	6	6 <sup>1</sup> / <sub>2</sub>	6 <sup>7</sup> / <sub>8</sub>	7 <sup>3</sup> / <sub>8</sub>	7 <sup>3</sup> / <sub>4</sub>
Linen Collection With Energy Shield™	3 <sup>1</sup> / <sub>2</sub>	3 <sup>7</sup> / <sub>8</sub>	4 <sup>1</sup> / <sub>4</sub>	4 <sup>5</sup> / <sub>8</sub>	5	5 <sup>3</sup> / <sub>8</sub>	5 <sup>3</sup> / <sub>4</sub>	6 <sup>1</sup> / <sub>8</sub>	6 <sup>5</sup> / <sub>8</sub>	7
Seclusions Collection Light Filtering	4	4 <sup>1</sup> / <sub>2</sub>	5	5 <sup>1</sup> / <sub>2</sub>	6	6 <sup>3</sup> / <sub>8</sub>	6 <sup>7</sup> / <sub>8</sub>	7 <sup>3</sup> / <sub>8</sub>	7 <sup>7</sup> / <sub>8</sub>	8 <sup>3</sup> / <sub>8</sub>
Seclusions Collection Room Darkening	4 <sup>1</sup> / <sub>8</sub>	4 <sup>5</sup> / <sub>8</sub>	5 <sup>1</sup> / <sub>8</sub>	5 <sup>5</sup> / <sub>8</sub>	6 <sup>1</sup> / <sub>8</sub>	6 <sup>5</sup> / <sub>8</sub>	7 <sup>1</sup> / <sub>8</sub>	7 <sup>5</sup> / <sub>8</sub>	8 <sup>1</sup> / <sub>8</sub>	8 <sup>5</sup> / <sub>8</sub>
Seclusions Collection With Energy Shield™	4	4 <sup>1</sup> / <sub>2</sub>	5	5 <sup>1</sup> / <sub>2</sub>	6	6 <sup>3</sup> / <sub>8</sub>	6 <sup>7</sup> / <sub>8</sub>	7 <sup>3</sup> / <sub>8</sub>	7 <sup>7</sup> / <sub>8</sub>	8 <sup>3</sup> / <sub>8</sub>
Sheer Essence Collection With Energy Shield™	2 <sup>1</sup> / <sub>2</sub>	2 <sup>3</sup> / <sub>4</sub>	3	3 <sup>1</sup> / <sub>4</sub>	3 <sup>1</sup> / <sub>2</sub>	3 <sup>3</sup> / <sub>4</sub>	4	4 <sup>1</sup> / <sub>4</sub>	4 <sup>1</sup> / <sub>2</sub>	4 <sup>5</sup> / <sub>8</sub>
Tree Bark Collection Light Filtering	3 <sup>7</sup> / <sub>8</sub>	4 <sup>1</sup> / <sub>8</sub>	4 <sup>5</sup> / <sub>8</sub>	5	5 <sup>1</sup> / <sub>2</sub>	5 <sup>7</sup> / <sub>8</sub>	6 <sup>3</sup> / <sub>8</sub>	6 <sup>7</sup> / <sub>8</sub>	7 <sup>1</sup> / <sub>4</sub>	7 <sup>3</sup> / <sub>4</sub>
Tree Bark Collection Room Darkening	3 <sup>7</sup> / <sub>8</sub>	4 <sup>3</sup> / <sub>8</sub>	4 <sup>7</sup> / <sub>8</sub>	5 <sup>1</sup> / <sub>4</sub>	5 <sup>3</sup> / <sub>4</sub>	6 <sup>1</sup> / <sub>8</sub>	6 <sup>5</sup> / <sub>8</sub>	7 <sup>1</sup> / <sub>8</sub>	7 <sup>1</sup> / <sub>2</sub>	8
Tree Bark Collection With Energy Shield™	3 <sup>7</sup> / <sub>8</sub>	4 <sup>1</sup> / <sub>4</sub>	4 <sup>3</sup> / <sub>4</sub>	5 <sup>1</sup> / <sub>8</sub>	5 <sup>5</sup> / <sub>8</sub>	6	6 <sup>1</sup> / <sub>2</sub>	7	7 <sup>3</sup> / <sub>8</sub>	7 <sup>7</sup> / <sub>8</sub>
Tricot Collection Light Filtering	2 <sup>3</sup> / <sub>4</sub>	3	3 <sup>3</sup> / <sub>8</sub>	3 <sup>5</sup> / <sub>8</sub>	4	4 <sup>1</sup> / <sub>4</sub>	4 <sup>1</sup> / <sub>2</sub>	4 <sup>7</sup> / <sub>8</sub>	5 <sup>1</sup> / <sub>8</sub>	5 <sup>1</sup> / <sub>2</sub>
Tricot Collection Room Darkening	2 <sup>7</sup> / <sub>8</sub>	3 <sup>1</sup> / <sub>8</sub>	3 <sup>1</sup> / <sub>2</sub>	3 <sup>7</sup> / <sub>8</sub>	4 <sup>1</sup> / <sub>8</sub>	4 <sup>1</sup> / <sub>2</sub>	4 <sup>7</sup> / <sub>8</sub>	5 <sup>1</sup> / <sub>4</sub>	5 <sup>1</sup> / <sub>2</sub>	5 <sup>7</sup> / <sub>8</sub>
Tricot Collection Light Filtering Double Cell	2 <sup>7</sup> / <sub>8</sub>	3 <sup>1</sup> / <sub>4</sub>	3 <sup>5</sup> / <sub>8</sub>	4	4 <sup>3</sup> / <sub>8</sub>	4 <sup>3</sup> / <sub>4</sub>	5 <sup>1</sup> / <sub>8</sub>	5 <sup>1</sup> / <sub>2</sub>	5 <sup>3</sup> / <sub>4</sub>	6 <sup>1</sup> / <sub>8</sub>
Tricot Collection Room Darkening Double Cell	3 <sup>1</sup> / <sub>8</sub>	3 <sup>1</sup> / <sub>2</sub>	3 <sup>7</sup> / <sub>8</sub>	4 <sup>1</sup> / <sub>4</sub>	4 <sup>3</sup> / <sub>4</sub>	5	5 <sup>3</sup> / <sub>8</sub>	5 <sup>7</sup> / <sub>8</sub>	6 <sup>1</sup> / <sub>8</sub>	6 <sup>5</sup> / <sub>8</sub>

# Stacking Chart

Stacking charts represent the amount of shade that is gathered at the top of the window, when the shade is fully raised. The measurements include the approximate height of the fabric, headrail, and bottom rail.

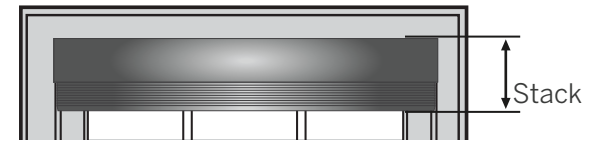

Stacking Chart — Corded (inches)										
Fabric Collection	36	48	60	72	84	96	108	120	132	144
Classic Collection Light Filtering	1 <sup>7</sup> / <sub>8</sub>	2 <sup>1</sup> / <sub>8</sub>	2 <sup>1</sup> / <sub>2</sub>	2 <sup>3</sup> / <sub>4</sub>	3	3 <sup>3</sup> / <sub>8</sub>	3 <sup>5</sup> / <sub>8</sub>	4	4 <sup>1</sup> / <sub>4</sub>	4 <sup>5</sup> / <sub>8</sub>
Classic Collection Room Darkening	2 <sup>1</sup> / <sub>4</sub>	2 <sup>5</sup> / <sub>8</sub>	3	3 <sup>3</sup> / <sub>8</sub>	3 <sup>3</sup> / <sub>4</sub>	4 <sup>1</sup> / <sub>8</sub>	4 <sup>1</sup> / <sub>2</sub>	5	5 <sup>1</sup> / <sub>4</sub>	5 <sup>3</sup> / <sub>4</sub>
Designer Colors Collection Light Filtering	2	2 <sup>3</sup> / <sub>8</sub>	2 <sup>3</sup> / <sub>4</sub>	3 <sup>1</sup> / <sub>8</sub>	3 <sup>1</sup> / <sub>2</sub>	3 <sup>7</sup> / <sub>8</sub>	4 <sup>1</sup> / <sub>4</sub>	4 <sup>1</sup> / <sub>2</sub>	4 <sup>7</sup> / <sub>8</sub>	5 <sup>1</sup> / <sub>4</sub>
Designer Colors Collection Room Darkening	2	2 <sup>1</sup> / <sub>4</sub>	2 <sup>5</sup> / <sub>8</sub>	3	3 <sup>1</sup> / <sub>4</sub>	3 <sup>5</sup> / <sub>8</sub>	4	4 <sup>1</sup> / <sub>4</sub>	4 <sup>5</sup> / <sub>8</sub>	5
Designer Colors Collection Light Filtering Double Cell	1 <sup>7</sup> / <sub>8</sub>	2 <sup>1</sup> / <sub>8</sub>	2 <sup>3</sup> / <sub>8</sub>	2 <sup>5</sup> / <sub>8</sub>	2 <sup>7</sup> / <sub>8</sub>	3 <sup>1</sup> / <sub>8</sub>	3 <sup>3</sup> / <sub>8</sub>	3 <sup>5</sup> / <sub>8</sub>	3 <sup>7</sup> / <sub>8</sub>	4 <sup>1</sup> / <sub>8</sub>
Designer Colors Collection Room Darkening Double Cell	2 <sup>3</sup> / <sub>8</sub>	2 <sup>5</sup> / <sub>8</sub>	2 <sup>7</sup> / <sub>8</sub>	3 <sup>1</sup> / <sub>8</sub>	3 <sup>3</sup> / <sub>8</sub>	3 <sup>5</sup> / <sub>8</sub>	3 <sup>7</sup> / <sub>8</sub>	4 <sup>1</sup> / <sub>8</sub>	4 <sup>3</sup> / <sub>8</sub>	4 <sup>5</sup> / <sub>8</sub>
Designer Textures Collection Light Filtering	2	2 <sup>1</sup> / <sub>2</sub>	2 <sup>7</sup> / <sub>8</sub>	3 <sup>1</sup> / <sub>4</sub>	3 <sup>5</sup> / <sub>8</sub>	4	4 <sup>3</sup> / <sub>8</sub>	4 <sup>3</sup> / <sub>4</sub>	5 <sup>1</sup> / <sub>8</sub>	5 <sup>1</sup> / <sub>2</sub>
Designer Textures Collection Room Darkening	2 <sup>1</sup> / <sub>8</sub>	2 <sup>1</sup> / <sub>2</sub>	2 <sup>7</sup> / <sub>8</sub>	3 <sup>1</sup> / <sub>4</sub>	3 <sup>5</sup> / <sub>8</sub>	4	4 <sup>3</sup> / <sub>8</sub>	4 <sup>3</sup> / <sub>4</sub>	5 <sup>1</sup> / <sub>8</sub>	5 <sup>5</sup> / <sub>8</sub>
Designer Textures Collection With Energy Shield™	2	2 <sup>1</sup> / <sub>4</sub>	2 <sup>5</sup> / <sub>8</sub>	3	3 <sup>1</sup> / <sub>4</sub>	3 <sup>5</sup> / <sub>8</sub>	4	4 <sup>3</sup> / <sub>8</sub>	4 <sup>5</sup> / <sub>8</sub>	5
Estria Collection Light Filtering	1 <sup>7</sup> / <sub>8</sub>	2 <sup>1</sup> / <sub>8</sub>	2 <sup>1</sup> / <sub>2</sub>	2 <sup>3</sup> / <sub>4</sub>	3	3 <sup>3</sup> / <sub>8</sub>	3 <sup>5</sup> / <sub>8</sub>	4	4 <sup>1</sup> / <sub>4</sub>	4 <sup>5</sup> / <sub>8</sub>
Estria Collection Room Darkening	2	2 <sup>1</sup> / <sub>4</sub>	2 <sup>5</sup> / <sub>8</sub>	3	3 <sup>1</sup> / <sub>4</sub>	3 <sup>5</sup> / <sub>8</sub>	4	4 <sup>3</sup> / <sub>8</sub>	4 <sup>5</sup> / <sub>8</sub>	5
Estria Collection Light Filtering Double Cell	2 <sup>1</sup> / <sub>8</sub>	2 <sup>3</sup> / <sub>8</sub>	2 <sup>5</sup> / <sub>8</sub>	2 <sup>7</sup> / <sub>8</sub>	3 <sup>1</sup> / <sub>8</sub>	3 <sup>3</sup> / <sub>8</sub>	3 <sup>5</sup> / <sub>8</sub>	3 <sup>7</sup> / <sub>8</sub>	4 <sup>1</sup> / <sub>8</sub>	4 <sup>3</sup> / <sub>8</sub>
Estria Collection Room Darkening Double Cell	2 <sup>3</sup> / <sub>8</sub>	2 <sup>5</sup> / <sub>8</sub>	2 <sup>7</sup> / <sub>8</sub>	3 <sup>1</sup> / <sub>8</sub>	3 <sup>3</sup> / <sub>8</sub>	3 <sup>5</sup> / <sub>8</sub>	3 <sup>7</sup> / <sub>8</sub>	4 <sup>1</sup> / <sub>8</sub>	4 <sup>3</sup> / <sub>8</sub>	4 <sup>5</sup> / <sub>8</sub>
Heathered Collection Light Filtering	2 <sup>7</sup> / <sub>8</sub>	3 <sup>3</sup> / <sub>8</sub>	3 <sup>3</sup> / <sub>4</sub>	4 <sup>1</sup> / <sub>4</sub>	4 <sup>5</sup> / <sub>8</sub>	5 <sup>1</sup> / <sub>8</sub>	5 <sup>1</sup> / <sub>2</sub>	6	6 <sup>3</sup> / <sub>8</sub>	6 <sup>7</sup> / <sub>8</sub>
Heathered Collection Room Darkening	3	3 <sup>1</sup> / <sub>2</sub>	4	4 <sup>3</sup> / <sub>8</sub>	4 <sup>7</sup> / <sub>8</sub>	5 <sup>1</sup> / <sub>4</sub>	5 <sup>3</sup> / <sub>4</sub>	6 <sup>1</sup> / <sub>4</sub>	6 <sup>5</sup> / <sub>8</sub>	7 <sup>1</sup> / <sub>8</sub>
Heathered Collection With Energy Shield™	3	3 <sup>1</sup> / <sub>2</sub>	4	4 <sup>3</sup> / <sub>8</sub>	4 <sup>7</sup> / <sub>8</sub>	5 <sup>1</sup> / <sub>4</sub>	5 <sup>3</sup> / <sub>4</sub>	6 <sup>1</sup> / <sub>4</sub>	6 <sup>5</sup> / <sub>8</sub>	7 <sup>1</sup> / <sub>8</sub>
Linen Collection Light Filtering	2	2 <sup>3</sup> / <sub>8</sub>	2 <sup>7</sup> / <sub>8</sub>	3 <sup>1</sup> / <sub>4</sub>	3 <sup>5</sup> / <sub>8</sub>	4	4 <sup>3</sup> / <sub>8</sub>	4 <sup>3</sup> / <sub>4</sub>	5 <sup>1</sup> / <sub>8</sub>	5 <sup>1</sup> / <sub>2</sub>
Linen Collection Room Darkening	2 <sup>7</sup> / <sub>8</sub>	3 <sup>3</sup> / <sub>8</sub>	3 <sup>7</sup> / <sub>8</sub>	4 <sup>1</sup> / <sub>4</sub>	4 <sup>3</sup> / <sub>4</sub>	5 <sup>1</sup> / <sub>8</sub>	5 <sup>5</sup> / <sub>8</sub>	6	6 <sup>1</sup> / <sub>2</sub>	6 <sup>7</sup> / <sub>8</sub>
Linen Collection With Energy Shield™	2 <sup>1</sup> / <sub>4</sub>	2 <sup>5</sup> / <sub>8</sub>	3	3 <sup>3</sup> / <sub>8</sub>	3 <sup>3</sup> / <sub>4</sub>	4 <sup>1</sup> / <sub>8</sub>	4 <sup>1</sup> / <sub>2</sub>	5	5 <sup>1</sup> / <sub>4</sub>	5 <sup>3</sup> / <sub>4</sub>
Seclusions Collection Light Filtering	3 <sup>1</sup> / <sub>4</sub>	3 <sup>7</sup> / <sub>8</sub>	4 <sup>3</sup> / <sub>8</sub>	4 <sup>7</sup> / <sub>8</sub>	5 <sup>1</sup> / <sub>2</sub>	6	6 <sup>1</sup> / <sub>2</sub>	7	7 <sup>5</sup> / <sub>8</sub>	8 <sup>1</sup> / <sub>8</sub>
Seclusions Collection Room Darkening	3 <sup>1</sup> / <sub>4</sub>	3 <sup>7</sup> / <sub>8</sub>	4 <sup>3</sup> / <sub>8</sub>	4 <sup>7</sup> / <sub>8</sub>	5 <sup>1</sup> / <sub>2</sub>	6	6 <sup>1</sup> / <sub>2</sub>	7 <sup>1</sup> / <sub>8</sub>	7 <sup>5</sup> / <sub>8</sub>	8 <sup>1</sup> / <sub>8</sub>
Seclusions Collection With Energy Shield™	3 <sup>1</sup> / <sub>4</sub>	3 <sup>7</sup> / <sub>8</sub>	4 <sup>3</sup> / <sub>8</sub>	4 <sup>7</sup> / <sub>8</sub>	5 <sup>1</sup> / <sub>2</sub>	6	6 <sup>1</sup> / <sub>2</sub>	7 <sup>1</sup> / <sub>8</sub>	7 <sup>5</sup> / <sub>8</sub>	8 <sup>1</sup> / <sub>8</sub>
Sheer Essence Collection With Energy Shield™	1 <sup>5</sup> / <sub>8</sub>	1 <sup>7</sup> / <sub>8</sub>	2 <sup>1</sup> / <sub>8</sub>	2 <sup>3</sup> / <sub>8</sub>	2 <sup>5</sup> / <sub>8</sub>	2 <sup>7</sup> / <sub>8</sub>	3 <sup>1</sup> / <sub>8</sub>	3 <sup>3</sup> / <sub>8</sub>	3 <sup>1</sup> / <sub>2</sub>	3 <sup>3</sup> / <sub>4</sub>
Tree Bark Collection Light Filtering	3 <sup>1</sup> / <sub>8</sub>	4 <sup>1</sup> / <sub>8</sub>	4 <sup>3</sup> / <sub>8</sub>	4 <sup>3</sup> / <sub>4</sub>	5	5 <sup>3</sup> / <sub>8</sub>	5 <sup>5</sup> / <sub>8</sub>	6	6 <sup>1</sup> / <sub>4</sub>	6 <sup>5</sup> / <sub>8</sub>
Tree Bark Collection Room Darkening	3 <sup>1</sup> / <sub>8</sub>	4 <sup>1</sup> / <sub>8</sub>	4 <sup>1</sup> / <sub>2</sub>	4 <sup>7</sup> / <sub>8</sub>	5 <sup>1</sup> / <sub>8</sub>	5 <sup>1</sup> / <sub>2</sub>	5 <sup>3</sup> / <sub>4</sub>	6 <sup>1</sup> / <sub>8</sub>	6 <sup>1</sup> / <sub>2</sub>	6 <sup>3</sup> / <sub>4</sub>
Tree Bark Collection With Energy Shield™	3 <sup>1</sup> / <sub>8</sub>	4 <sup>1</sup> / <sub>8</sub>	4 <sup>1</sup> / <sub>2</sub>	4 <sup>7</sup> / <sub>8</sub>	5 <sup>1</sup> / <sub>8</sub>	5 <sup>1</sup> / <sub>2</sub>	5 <sup>3</sup> / <sub>4</sub>	6 <sup>1</sup> / <sub>8</sub>	6 <sup>1</sup> / <sub>2</sub>	6 <sup>3</sup> / <sub>4</sub>
Tricot Collection Light Filtering	1 <sup>7</sup> / <sub>8</sub>	2 <sup>1</sup> / <sub>8</sub>	2 <sup>1</sup> / <sub>2</sub>	2 <sup>3</sup> / <sub>4</sub>	3	3 <sup>3</sup> / <sub>8</sub>	3 <sup>5</sup> / <sub>8</sub>	4	4 <sup>1</sup> / <sub>4</sub>	4 <sup>5</sup> / <sub>8</sub>
Tricot Collection Room Darkening	2	2 <sup>1</sup> / <sub>4</sub>	2 <sup>5</sup> / <sub>8</sub>	3	3 <sup>1</sup> / <sub>4</sub>	3 <sup>5</sup> / <sub>8</sub>	4	4 <sup>3</sup> / <sub>8</sub>	4 <sup>5</sup> / <sub>8</sub>	5
Tricot Collection Light Filtering Double Cell	2 <sup>1</sup> / <sub>8</sub>	2 <sup>3</sup> / <sub>8</sub>	2 <sup>5</sup> / <sub>8</sub>	2 <sup>7</sup> / <sub>8</sub>	3 <sup>1</sup> / <sub>8</sub>	3 <sup>3</sup> / <sub>8</sub>	3 <sup>5</sup> / <sub>8</sub>	3 <sup>7</sup> / <sub>8</sub>	4 <sup>1</sup> / <sub>8</sub>	4 <sup>3</sup> / <sub>8</sub>
Tricot Collection Room Darkening Double Cell	2 <sup>3</sup> / <sub>8</sub>	2 <sup>5</sup> / <sub>8</sub>	2 <sup>7</sup> / <sub>8</sub>	3 <sup>1</sup> / <sub>8</sub>	3 <sup>3</sup> / <sub>8</sub>	3 <sup>5</sup> / <sub>8</sub>	3 <sup>7</sup> / <sub>8</sub>	4 <sup>1</sup> / <sub>8</sub>	4 <sup>3</sup> / <sub>8</sub>	4 <sup>5</sup> / <sub>8</sub>

# Motorization Overview

## LEVOLOR® InMotion™

Experience motorization like never before with smart home integration and automated scheduling. Take full control of your shades using voice command, the intuitive app, or remote.

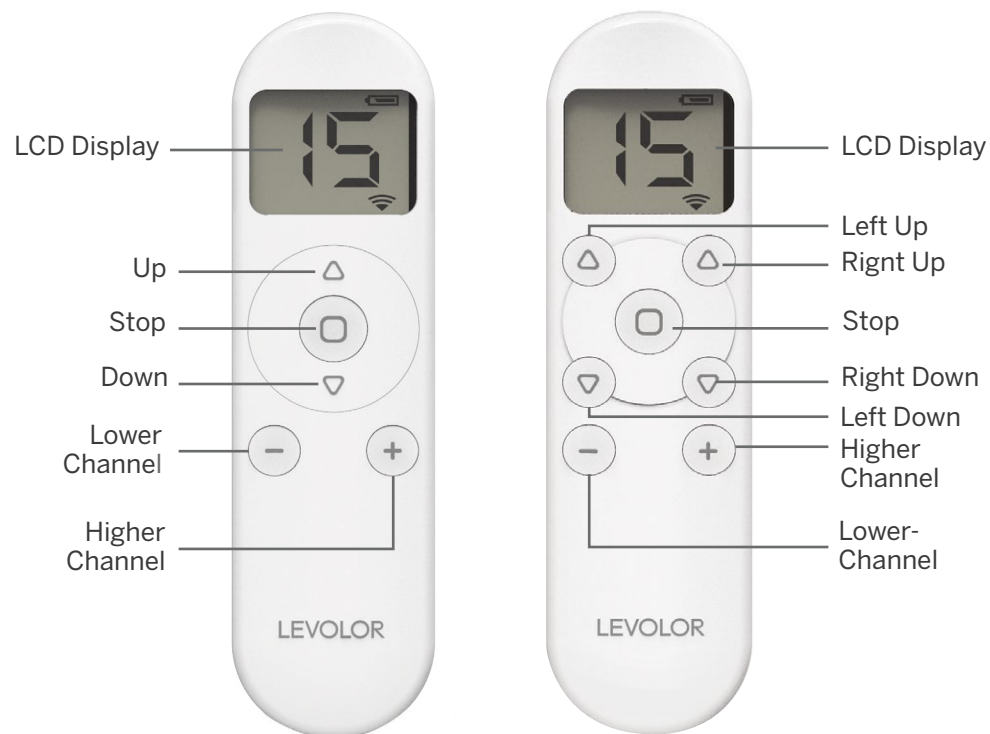

**Standard Remote**  
Requires 2 x AAA  
batteries, included.

**Top-Down/Bottom-Up,  
Day/Night Remote**  
Requires 2 x AAA  
batteries, included.



**Hub**  
Requires 5V 2A adapter, included.  
Connect up to 30 shades per hub.

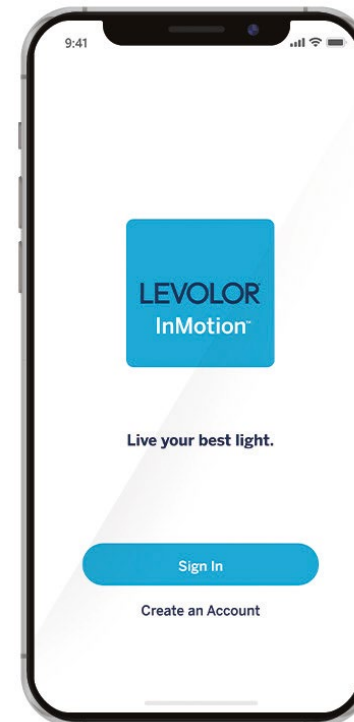

**App**  
Phone sold separately

**App Requirements:**  
- LEVOLOR Hub  
- 2.4 GHz Wi-Fi Network  
- Apple® iOS10.0 or newer  
- Android™ 4.1 or newer

**Works With:**  
- Amazon Alexa  
- Google Home  
- IFTT  
- Samsung SmartThings  
- Siri

- Upgrade to motorization to control shades with remote or app.
- Powered by an integrated, rechargeable lithium-ion battery.
- Recharge with included magnetic micro-USB charger.
- Control shades with the 15-channel remote (sold separately).
- Add the hub (sold separately) to sync with your Wi-Fi to enable app control and smart home integration.
- Organize shades by room.

- See real-time shade position and battery charge status.
- Store preset shade positions as scenes.
- Create routines by scheduling scenes by day of week and time of day, even proximity to sunrise or sunset.
- Adjust shades when you are away from home.
- App available to download for iOS and Android devices.
- Available on bottom-up, top-down/bottom-up, and day/night shades. Control all rails independently.

Visit [LEVOLOR.com/InMotion](https://LEVOLOR.com/InMotion) for additional information.

NOTE: LEVOLOR® InMotion™ is not compatible with products from the previous LEVOLOR® motorization program. This includes blinds/shades that are controlled with the previous LEVOLOR app, 3-channel remote, and 6-channel remote.

For additional information visit [LEVOLOR.com](https://LEVOLOR.com)

## Cellular Hardware Color Coordination Guide

Coordinating hardware colors are pre-selected based on fabric color. The color samples below represent headrail, bottom rail, end cap, and tassel colors.

The Fabric Index chart on the following page identifies which hardware color number matches each fabric color.

00110	00275	00292	50001	50002	50003
700114	70121	70134	70136	70145	70147
70152	70800	70802	70803	70804	80001
80006	80012	80031	80120	80166	80204
80310	RE011	BE018	GY051	OR001	

**NOTE:** The actual color of the hardware may vary from the samples in the color coordination guide.

Color lot variations may occur with fabric and/or hardware due to the process of color application. For the best color match, order all shades for a room at the same time. Pattern availability and color lot match between orders cannot be assured.

# Parts and Components

Corded		Component Part Number
A	Installation Brackets 2 PK	HFPK0012
B	Cord Cleat	HGTS000170803
C	3/8" Spacer Block	W02E0000
D	Hold Down Bracket Kit	DJL01873
F & G	Side Mount Brackets	HBEX0002 & HBEX0001
F & G	2 Part Extension Brackets Extends out 1 in. to 1.5 in. or 2.5 in. to 3 in.	HBEX0002 & HBEX0001
H & G	2 Part Extension Brackets Extends out 1.5 in. to 2.5 in.	HBEX0003 & HBEX0001

Cord Loop		Component Part Number
E	Installation Bracket Kit	HFPK0027
J	Tension Device	1861145
C	Hold Down Bracket Kit	W02E0000
D	Spacer Blocks	DJL01873
F & G	Side Mount Brackets	HBEX0002 & HBEX0001
F & G	2 Part Extension Brackets Extends out 1 in. to 1.5 in. or 2.5 in. to 3 in.	HBEX0002 & HBEX0001
H & G	2 Part Extension Brackets Extends out 1.5 in. to 2.5 in.	HBEX0003 & HBEX0001

Cordless		Component Part Number
E	Installation Brackets 2 PK	HFPK0027
K	Clear plastic handle	1896468
C	3/8" Spacer Block	W02E0000
D	Hold Down Bracket Kit	DJL01873
H	Side Mount Brackets	HBEX0002 & HBEX0001
F & G	2 Part Extension Brackets Extends out 1 in. to 1.5 in. or 2.5 in. to 3 in.	HBEX0002 & HBEX0001
H & G	2 Part Extension Brackets Extends out 1.5 in. to 2.5 in.	HBEX0003 & HBEX0001

Motorized		Component Part Number
I	Mounting Bracket 2-Pack	KIT2758
J	Mounting Bracket 3-Pack	KIT2759
K	Extension Bracket 2-Pack	KIT2013
L	Extension Bracket 3-Pack	KIT2014
M	Hub (optional)	1029593
N	Motorized Remote Control Kit (optional)	1029591
O	10' Micro-USB to USB Charging Cable	62206300
P	Power Adapter	62200000
Q	Elbow Magnetic Charging Adapter	62206400
R	Magnetic Insert	62206200
S	End Mount Bracket Kit	KIT2762
T	Motorized Remote Control Kit - Top-Down/ Bottom-Up and Day/Night (optional)	1029592

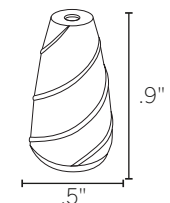
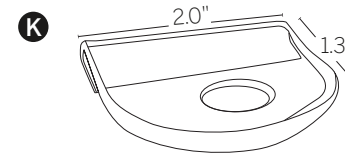
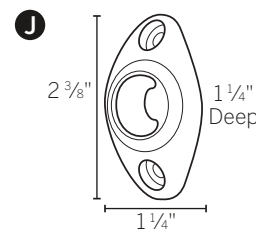
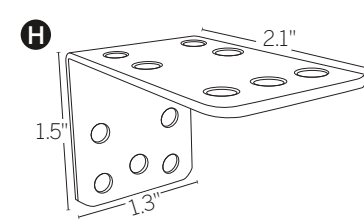
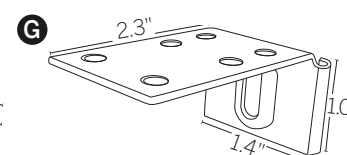
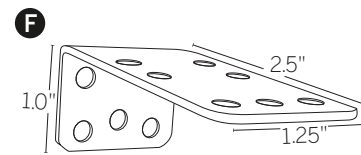
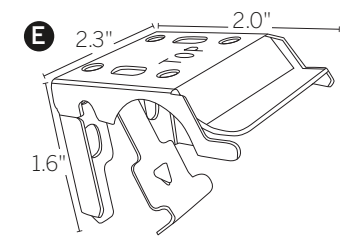
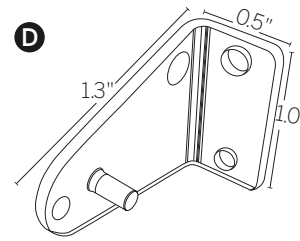
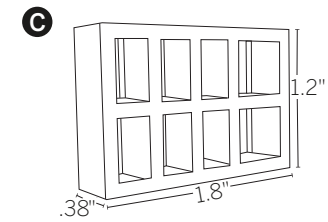
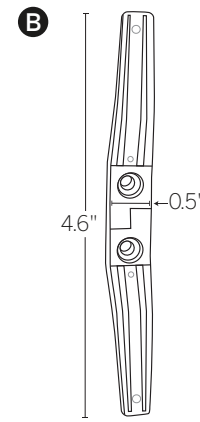
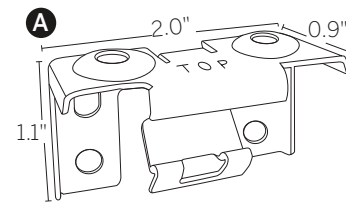

Dimensions shown for tassel. Cannot be ordered separately.

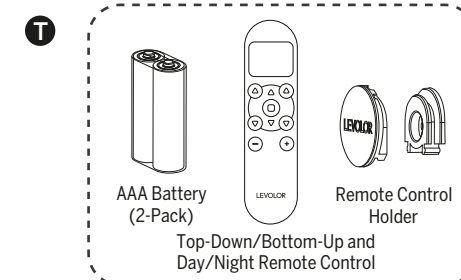
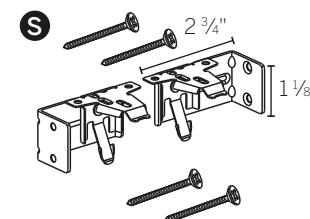
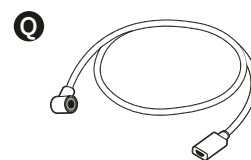
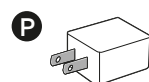
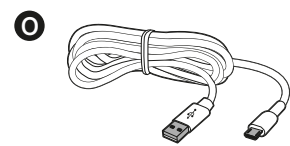
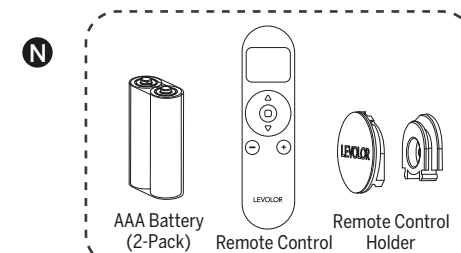
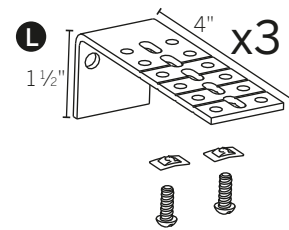
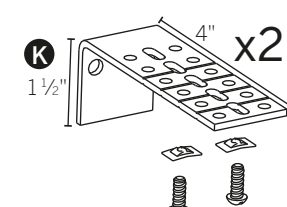
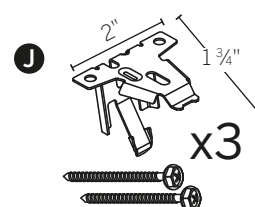
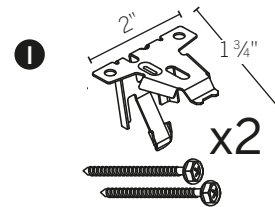

## Specialty Shapes

Specialty Shapes such as skylights, arches and angles are available. Some options will function as a traditional shade, others are stationary. For information about specialty shapes, sizing options, critical dimensions and steps for creating a template visit [LEVOLOR.com/cellularoptions](http://LEVOLOR.com/cellularoptions).

### SPECIALTY SHAPE OPTIONS:

- Arch
- Octagon
- Hexagon
- Half Arch
- Skylight
- Cutout
- Circle
- Fanned Angle
- Bay Windows

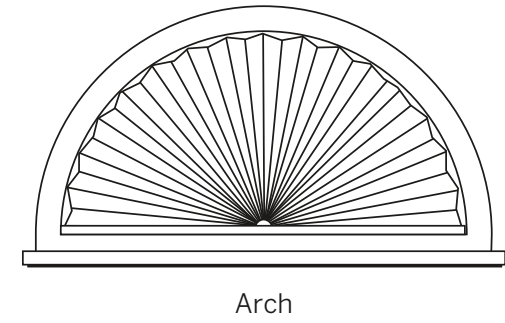
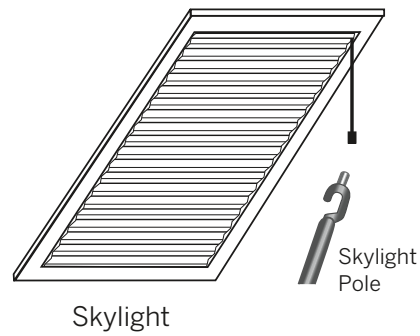

A skylight pole can be purchased separately to raise and lower skylights, some specialty shapes and any hard to reach cordless shades.

## Cleaning and Care

All LEVOLOR Cellular Shades are made of 100% polyester and with multiple cleaning options, these easy to care for shades will maintain their beautiful appearance for years to come.

**Note:** Improper cleaning may void warranty



### DUSTING

Use a feather duster for regular cleaning.



### VACUUMING

Use a low suction vacuum with a brush-type cleaner attachment; stroke lightly over the shade to clean.



### FORCED AIR

Blow away dirt and debris using clean compressed air.



### SPOT-CLEANING/STAIN REMOVAL AT HOME

Use warm water and a mild soap, like Woolite® or Scotchgard®, if needed.



### PROFESSIONAL INJECTION/EXTRACTION CLEANING

Call local on-site blind/shade cleaner that injects a cleaning solution into the fabric and extracts the dirty solution at the same time. The service is typically performed at home so you do not need to remove your window treatments.

The following information, listed below, is available online at [LEVOLOR.com](http://LEVOLOR.com)

- Terms and Conditions
- Freight
- Warning and Safety Information
- Order Processing
- Claims and Returns
- Warranty